

Build, Maintain, and Expand Your **Greenhouse Operation** With Confidence



Contact us



(365)-524-7869



ApexEquipmentSolutions.com



Info@ApexEquipmentSolutions.com



1 Hunter St. East, Suite G100,
Hamilton, ON L8N 3W1



Why Choose Us?

- Our structures are built for strength and efficiency.
- Responsive and knowledgeable team.
- Constructed with 50 KSI Certified Steel: 52% stronger than the commercial-grade steel commonly used in other greenhouse frames.
- Well designed and easy to assemble structures.
- Innovative solutions driven by continuous product knowledge and improvement.
- Our arches are made from premium oval tubing to better withstand environmental conditions.

Strength Advantage of Oval Tubing

Common Tubing	Oval Tubing	Oval Advantage
1.90" Round 14 ga	1-5/8" x 2-3/4" 16 ga	100% stronger
2" Round 14 ga	1-5/8 x 2-3/4" 16 ga	75% stronger
2-3/8" Round 16 ga	1-5/8 x 2-3/4" 16 ga	28% stronger



Freestanding Structures

Available Widths:

25' | 27' | 30' | 35' | 42'

- Arches are built with oval tubing, which is unmatched for wind and snow resistance.
- Efficient design lets in an abundance of light to promote uniform crop growth.
- Inside clearance ranges from 6'6" to 12'7" depending on width size.
- Engineered to enhance natural ventilation, creating a favorable environment for healthy crops
- Great economical option for floriculture and nursery crops.
- Well designed and easy to assemble.

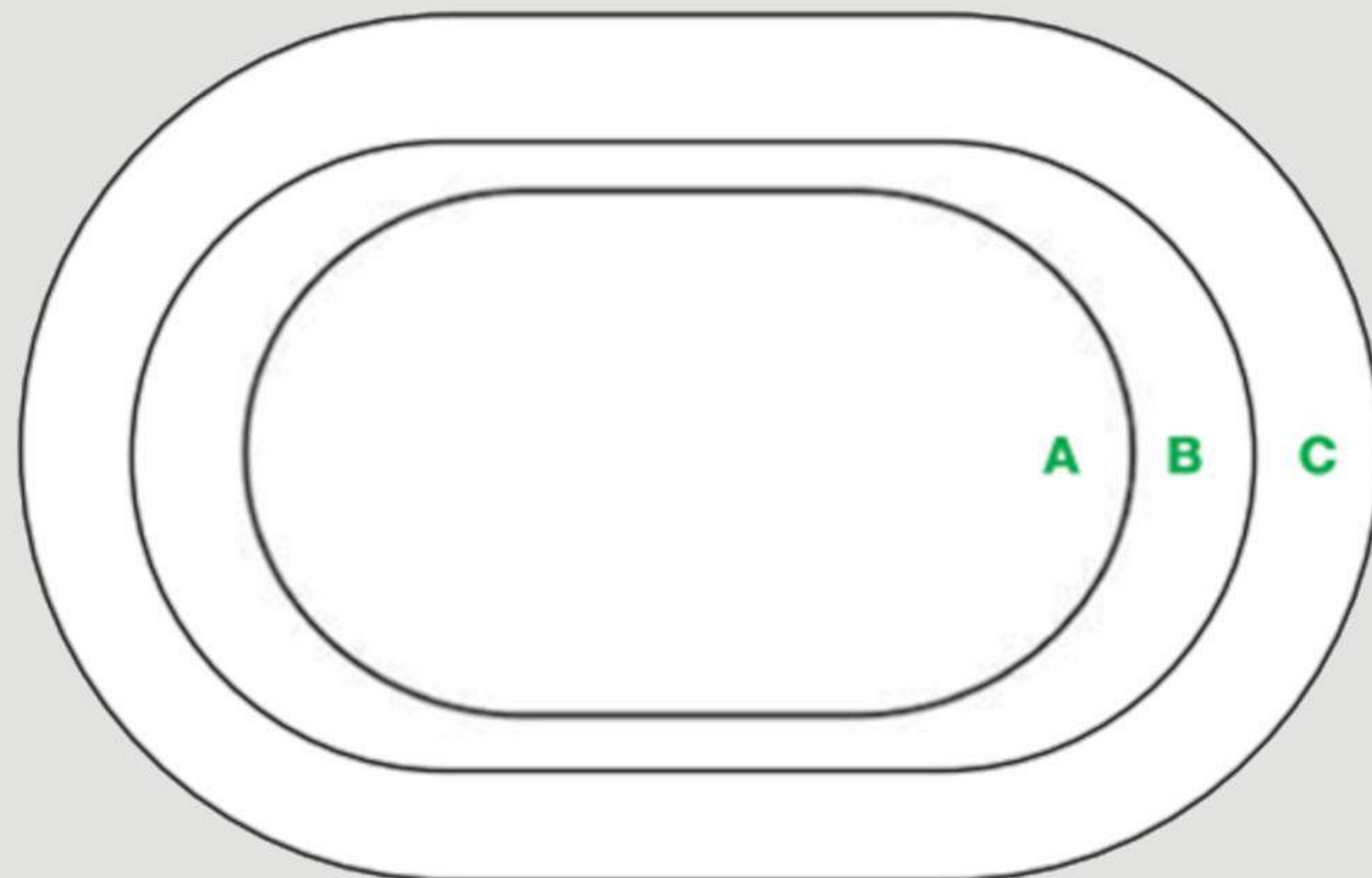

A
1 5/8" x 2 3/4"
16 GAUGE

B
2" x 3 9/16"
16 GAUGE

C
2 3/4" x 4 5/16"
14 GAUGE



Gutter Connect Structures

Available Widths:

21'-4" | 24' | 25' | 26'-3" | 30' | 31'-6" | 36'

- Built for strength and durability, engineered for your needs and easy to assemble.
- Efficient design lets in an abundance of light to promote uniform crop growth.
- Simplified climate stability at the crop level.
- Arch is built with oval tubing and Gothic geometry for optimal snow shedding.
- Large air volume above the gutter level.
- Ideal for garden centers, nursery, and produce growers.

Standard Gutter Height Options (GH)

12' | 14' | 16' | 18' | 19'-8" (6m)

Minimum Distance Below Truss (A)

Truss sizes vary. Contact us to discuss available options.

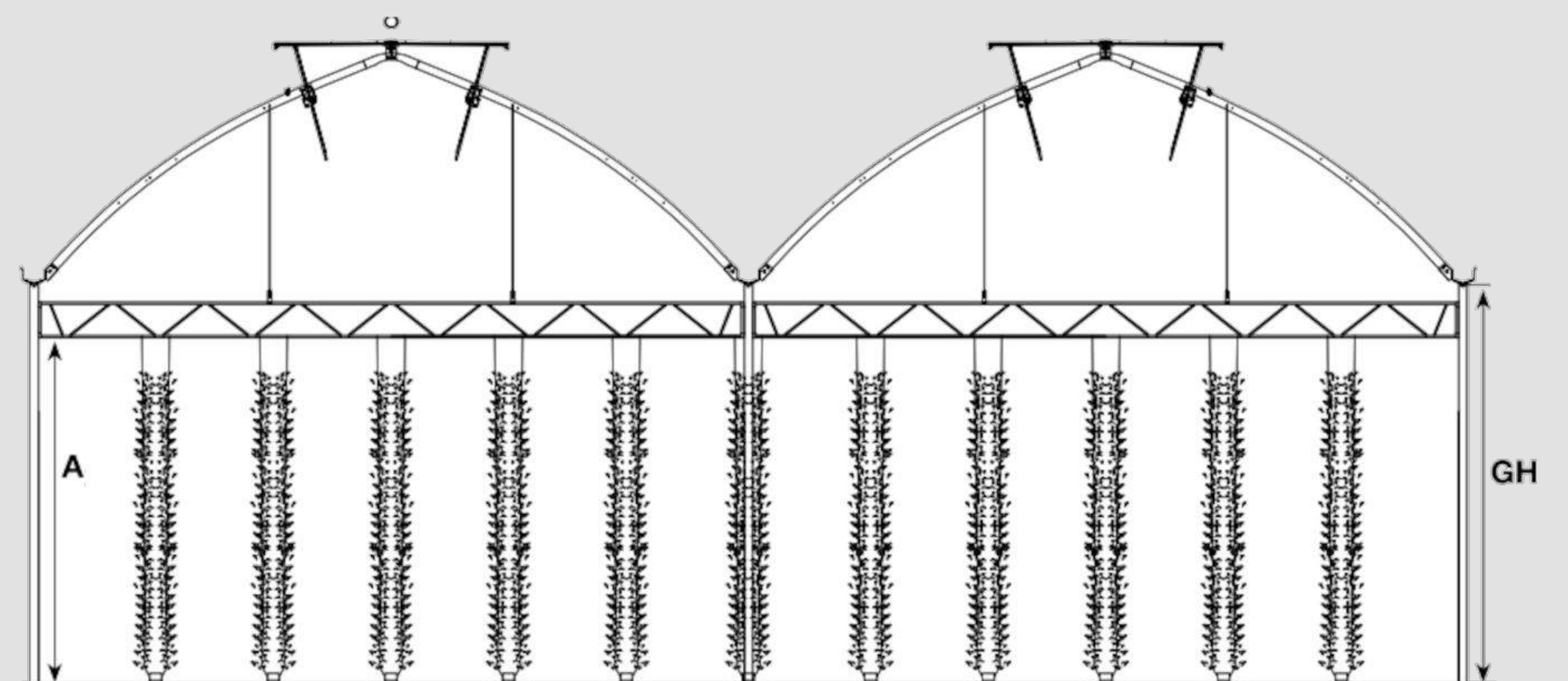



High Tunnel Structures

Available Widths:
31'-6"

- Great economical option for field crops.
- Lower operating costs (labor and machinery)
- Reduced water and fertilizer consumption.
- Better product quality and predictability.
- Full access is available for tractors and workers.
- Reduced use of phytosanitary products.

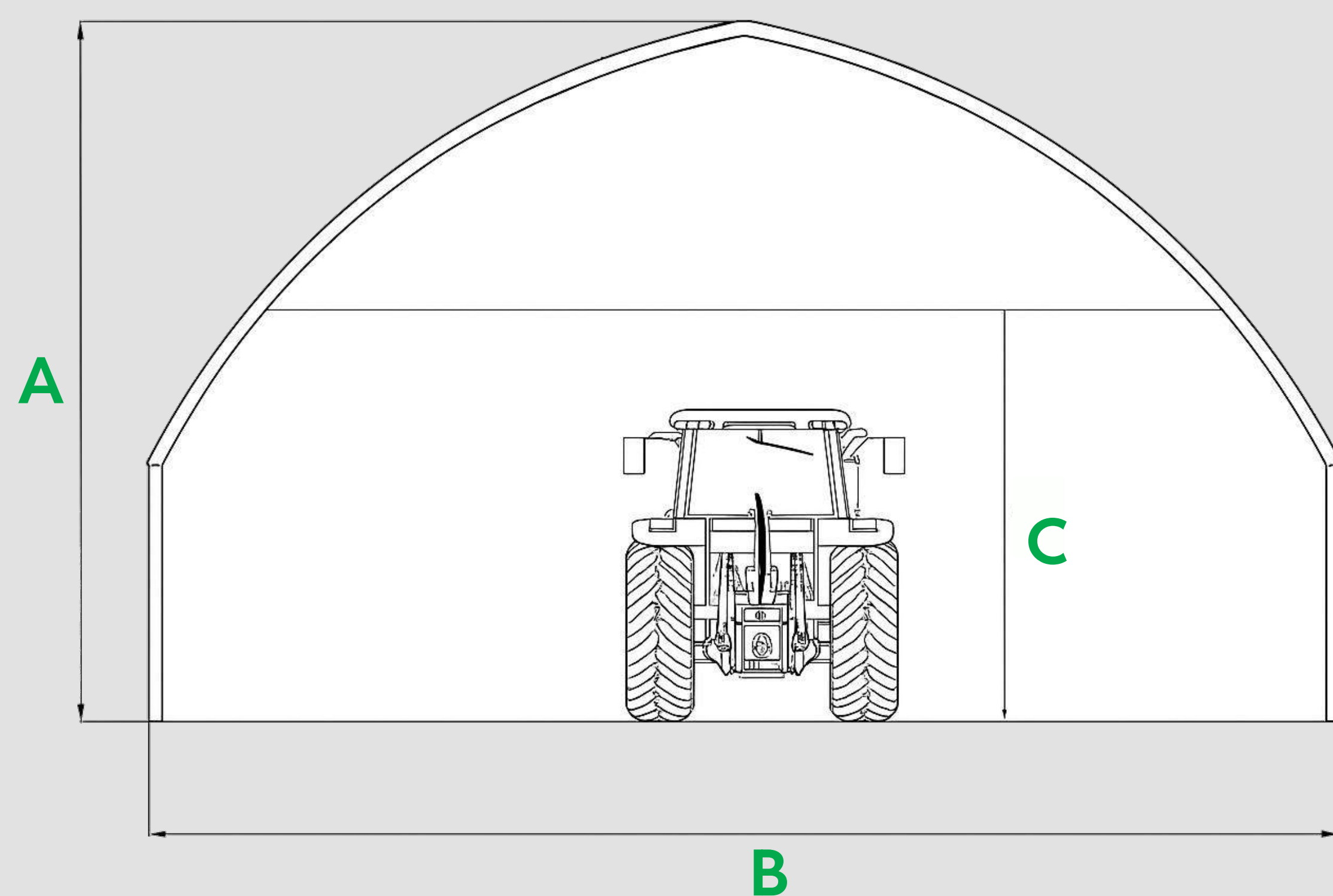

A
Peak Height: 17'-8"

B
Width: 31'-6"

C
Tractor Access: 10'-6"

Greenhouse Covering Material

We offer a range of high-quality covering materials to suit different growing needs and budgets. Each option provides its own balance of light transmission, insulation, and durability.

- **Polyethylene Film (Poly):** A cost-effective and flexible option that provides excellent light diffusion and easy installation. Available in single or double layers for improved insulation.
- **Polycarbonate Panels:** Strong, long-lasting, and highly impact-resistant. Available in clear or diffused finishes, they offer excellent insulation and UV protection.
- **Glass:** The traditional choice for clarity and longevity. Ideal for permanent structures where maximum light transmission and a professional appearance are desired.

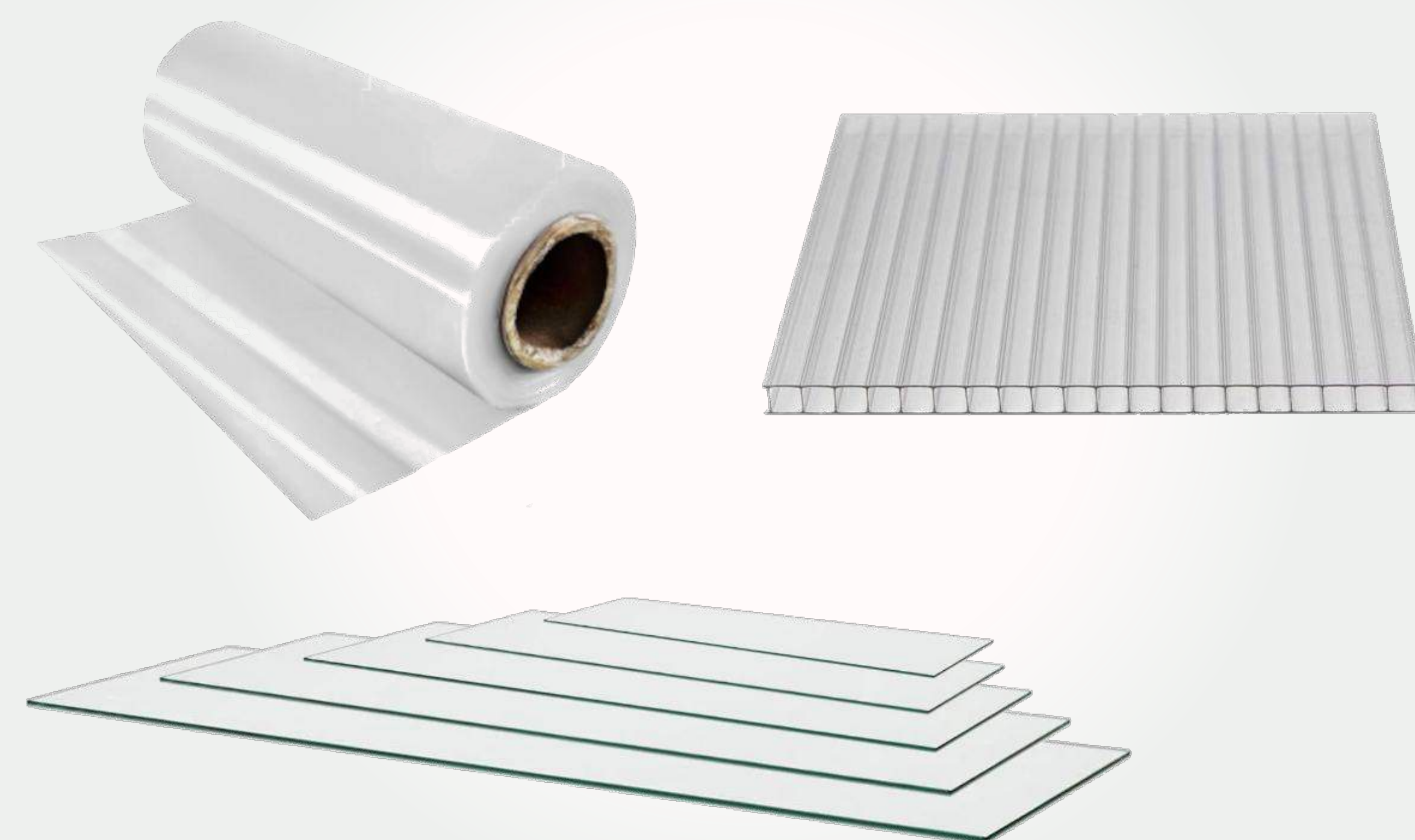

Shading Systems

Our shading systems help control light levels and temperature inside the greenhouse, creating a more stable and efficient growing environment.

Available in manual or automated options, shading systems can reduce heat buildup on sunny days, protect plants from excess light, and improve energy efficiency.

We offer a variety of curtain materials and configurations to suit different crops and structure types — from light-diffusing fabrics to blackout systems for photoperiod control.



Control Systems

Our automated control system helps you manage your greenhouse environment with ease. It monitors temperature, humidity, and other key conditions, then automatically adjusts fans, vents, heaters, and other equipment to maintain the ideal growing climate.

Simple to use and easy to program, the system can be customized for your specific crops and growing seasons. It helps reduce manual work, improve consistency, and create better growing conditions for higher yields.

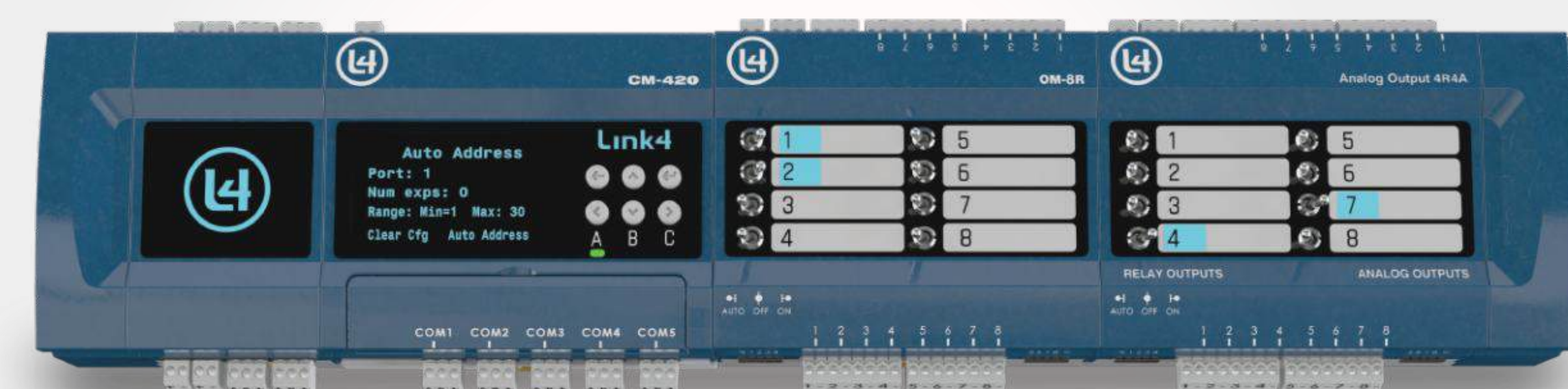

Lighting

Our greenhouse lighting systems provide the flexibility to maintain optimal growing conditions year-round. Whether used to supplement natural sunlight or as a primary light source, these systems help promote healthy growth, uniform development, and improved yields.

Available in various configurations, lighting can be tailored to specific crops, growth stages, and seasonal needs. Automated controls and scheduling options make it easy to manage light levels and energy use efficiently.



Fogging Systems

Our fogging systems provide precise humidity and cooling control for optimal growing conditions. By producing a fine mist, these systems help maintain consistent moisture levels in the air, reduce plant stress, and lower temperatures during hot periods.

Fogging can be used for propagation areas, high-humidity crops, or general climate management. Designed for efficiency and reliability, these systems improve plant health while helping to reduce water and energy use.



Air Circulation

Proper air movement is essential for maintaining a healthy and consistent greenhouse environment. Our air circulation systems include a range of equipment such as circulation fans, exhaust fans, and shutters — all designed to promote uniform airflow and temperature control throughout the structure.

These systems help prevent hot spots, reduce humidity buildup, and improve overall plant health. Available in various sizes and configurations, they can be tailored to suit any greenhouse layout and ventilation requirement.









Ready to get started?

We'd be happy to help you find the right structure or equipment for your operation. Contact us today for a quote or to chat about your next project.



-  (365)-524-7869
-  [ApexEquipmentSolutions.com](https://www.ApexEquipmentSolutions.com)
-  Info@ApexEquipmentSolutions.com
-  1 Hunter St. East, Suite G100,
Hamilton, ON L8N 3W1